

DOORS & BUILDING COMPONENTS
2002 DBCI ALL RIGHTS RESERVED

COMMERCIAL DOOR INSTALLATION INSTRUCTIONS

SERIES 2000, 2500, 3100 & 3400

In the following text, the word:

WARNING means that serious injury or death can result from failure to follow instructions.

CAUTION means that minor injury or property damage can result from failure to follow instructions.

NOTE means that special attention should be given to the instructions.

CAUTION

Use proper lifting equipment and correct procedures to avoid injury.

DO NOT CUT TAPE OR PLASTIC which holds the door in a roll. You will be told at a later time exactly when to cut these items. No guarantee will be given or responsibility accepted by the manufacturer if door is not erected as instructed. For proper operation, follow the instructions given. Please review all instructions before starting actual work.

Overhead doors are large, heavy objects that move with the help of springs under high tension. Since moving objects and springs under tension can cause injuries, your safety and the safety of others depends on your reading and following the information in these instructions. DBCI recommends that only properly trained personnel should install tension doors.

POTENTIAL HAZARD	EFFECT	PREVENTION
MOVING DOOR	Can cause serious injury or death	Keep people clear of opening while door is moving. Get help or use support when lifting new door into place.
HIGH SPRING TENSION	Can cause serious injury or death	Installation, repairs and adjustments must be made by a trained service person using proper tools, methods and instructions. Before winding torsion spring, make sure door is fully open and curtain is wrapped on drums.

1 CHECK DOOR OPENING.

- A** Check the width and height of the door opening and verify the measurements against the sizes shown on the door packing slip.
- B** Check door jambs for plumb, to ensure proper door alignment and performance.
- C** Check header and floor for level, to ensure proper door alignment and performance.
- D** Check to be sure that there is sufficient side clearance at the jambs and at the head room above the door opening. (See table A).
- E** The jamb surface, to which the guide is to be attached, should be flush for mounting purposes.

MINIMUM DIMENSION PANEL FOR SERIES 1000 - 2250

	A-1	A-2	B (MIN.)	C	D
HAND OPERATED - PULL ROPE					
UP TO 8'-0" HIGH	5"	5"	17"	10"	≈10"
UP TO 10'-0" HIGH	5"	5"	19"	10"	≈11"
CHAIN OPERATED - DIRECT OR REDUCED					
UP TO 8'-0" HIGH	8-1/2"	5"	17"	10"	≈10"
UP TO 10'-0" HIGH	8-1/2"	5"	19"	10"	≈11"
OVER 10'-0" HIGH	8-1/2"	5"	21"	10"	≈12"

MINIMUM DIMENSION PANEL FOR SERIES 2500 - 3250

	A-1	A-2	B (MIN.)	C	D
HAND OPERATED - PULL ROPE					
UP TO 8'-0" HIGH	6-1/2"	6-1/2"	19"	10"	≈10"
UP TO 10'-0" HIGH	6-1/2"	6-1/2"	21"	10"	≈11"
CHAIN OPERATED - DIRECT OR REDUCED					
UP TO 8'-0" HIGH	10"	6-1/2"	19"	10"	≈10"
UP TO 10'-0" HIGH	10"	6-1/2"	21"	10"	≈11"
OVER 10'-0" HIGH	10"	6-1/2"	23"	10"	≈12"

TABLE "A"

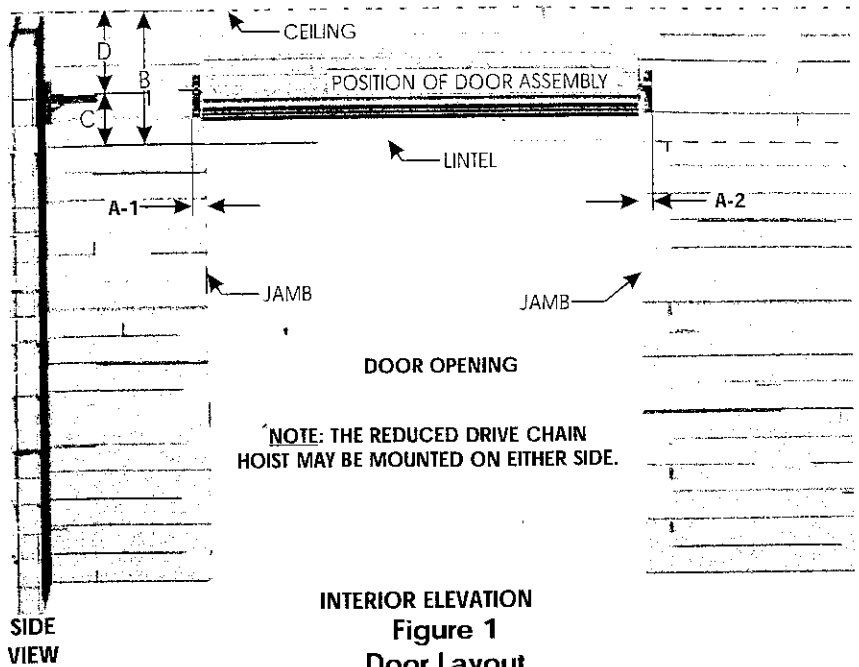

2 DOOR ARRANGEMENT.

2A Lay door on a clean floor inside of building and in front of opening. See Figure 1.

NOTE: Door can be damaged if laid on unclean surface.

2B Distribute parts bags, guides, stops and brackets.

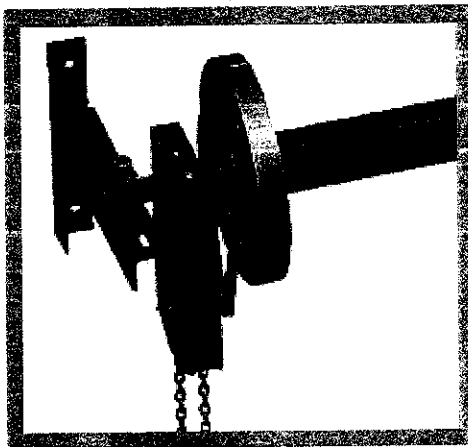

**4.4:1 Reduced Drive System
Figure 2A**

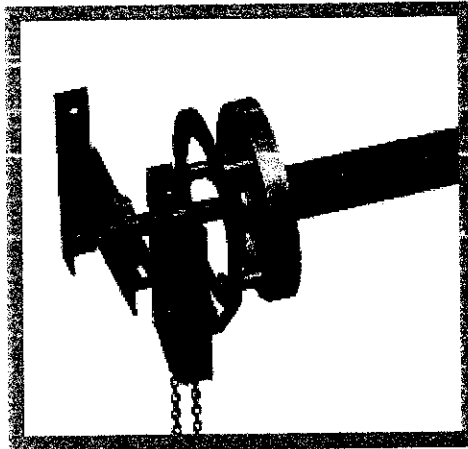

**8:1 Reduced Drive System
Figure 2B**

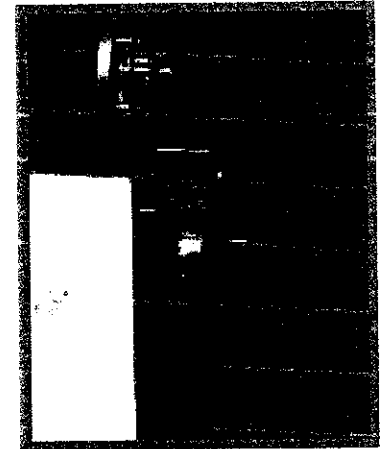

**Electrically Operated System
Figure 2C**

3 OPTIONAL REDUCED DRIVE SYSTEMS

If door is to be operated by a reduced drive unit, install the sprocket on the preferred side (as illustrated in Figure 1). Slide the reduced drive assembly over the axle and align the sprockets parallel to each other. Connect the drive chain around both sprockets, using the halflink and masterlink units provided. After the door's tension has been adjusted (as shown in Step 8), tighten the set screws on the reduction drive shaft onto the door axle. If further adjustment is needed, set screws must be loosened for adjustment and then re-tightened after the final adjustment.

4 INSTALL DOOR BRACKETS

4A From dimensions on panel in Tables 1 & 2 mark the location of brackets by using dimension "A-1" for the chain hoist side and dimension "A-2" for the other side. If opening width of the door is less than shown on the packing slip, establish dimension "A-1" and "A-2" by placing the door drum assembly on the floor in front of the door opening and placing the brackets as required to clear the door drum, chain gear assembly, etc.

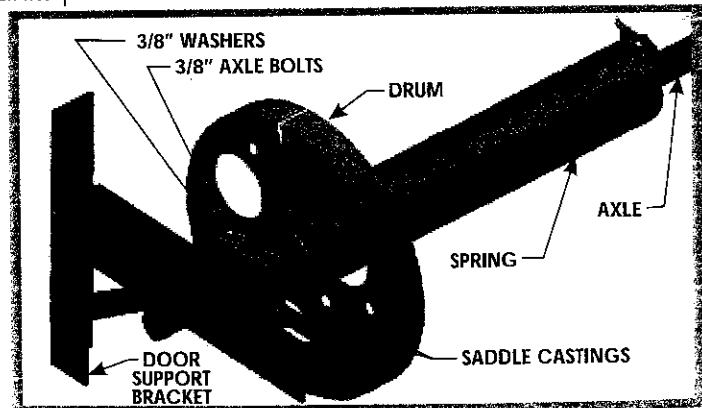

**BRACKET MOUNT PREPARATION
Figure 3**

2)

SERIES 2000/2500/3100 & 3400

4B Mark the height of the bracket by using dimension "C". Measure the ceiling clearance and check this against dimension "D" to verify that the minimum ceiling clearance has been obtained. If dimension "D" has not been obtained, lower the brackets accordingly.

NOTE The brackets must be level with each other for proper door operation.

4C If the bracket height has been lowered, it will be necessary to cut and re-notch the guide bottoms the amount lowered.

NOTE The finished door height will be shorter.

4D Attach brackets with fasteners provided to obtain a solid mount.

NOTE Use through bolts on soft brick or block.

5 PREPARING SADDLES FOR AXLE PLACEMENT

STANDARD SYSTEM (for doors without reduced drive system).

5A Using one saddle per bracket, place the Axle saddles on the top of the bracket with it's "teeth" facing upward by inserting the shoulder bolts in the appropriate slots that you choose (as illustrated in Figure 6A & 6B)

6 LIFTING DOOR DRUM ASSEMBLY

It is recommended when using a forklift to adequately pad the forklift's "forks" to prevent damage and/or scratching to the door. (See Figure 4)

6A Lift the door up and position it between both the left and right openings between the upper and lower "Axle Saddles", loosely fastened to the mounting brackets.

6B Center the door over the opening. If sideway movements are necessary, make sure that the door and axle move together.

6C Position the door as close as possible to the door header and still be able to rotate the door freely around the axle.

6D When finally placing the axle within the Axle Saddles, ensure that the indication arrows are in the directions shown in Figure 5. These are the only positions that will allow the Axle Saddles to properly lock the axle into place. If this action is not properly followed, you will not be able to properly tension the door.

7 SECURE THE AXLE SADDLES

STANDARD SYSTEM (for doors without reduced drive system).

7A Place the Axle saddles over the top and under the bottom of the door axle, as shown in Figure 5. Paying attention to arrows.

7B Install the bolts, washers and nuts as shown in Figures 6A and 6B taking very great care to tighten BOTH nuts to a torque of 40 foot pounds pull at the end of a 12" wrench.



LIFTING DOOR ASSEMBLY IN PLACE

Figure 4

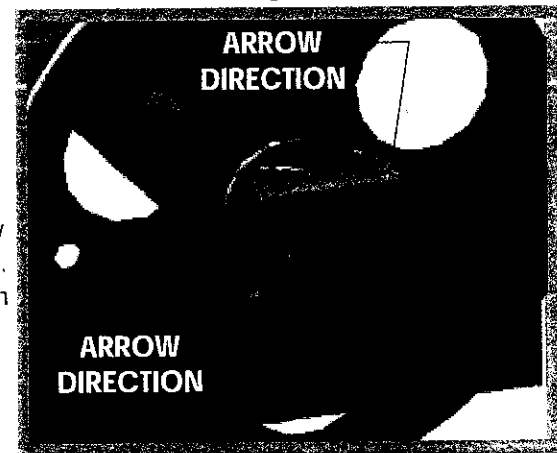

SADDLE ARROW DIRECTIONS

Figure 5

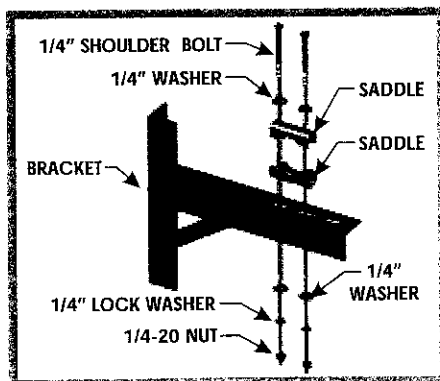

SADDLE PLACEMENT: 6'-0" TO 8'-10" TALL DOOR

Figure 6A

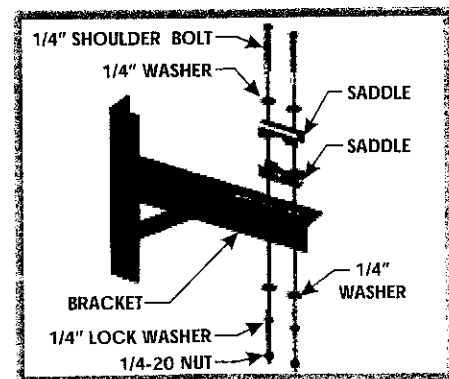

SADDLE PLACEMENT: DOORS OVER 8'-10" TALL

Figure 6B



WARNING

DO NOT ATTEMPT TO INSTALL OR ADJUST THE CURTAIN SYSTEM WITHOUT PROPER TRAINING. FAILURE TO FOLLOW THESE INSTRUCTIONS MAY CAUSE SERIOUS INJURY AND/OR DAMAGE TO PROPERTY.

8 PRE-TENSION DOOR SPRINGS

8A The bottom bar should be in a downward or "6 o'clock position", while the springs are relaxed. Apply tension to the springs by rotating the door 2 complete turns in a forward direction (as shown in Figure 7).

8B The amount of tension required to properly counter-balance the door will vary from door to door. Final adjustment of springs will be made in step 9.

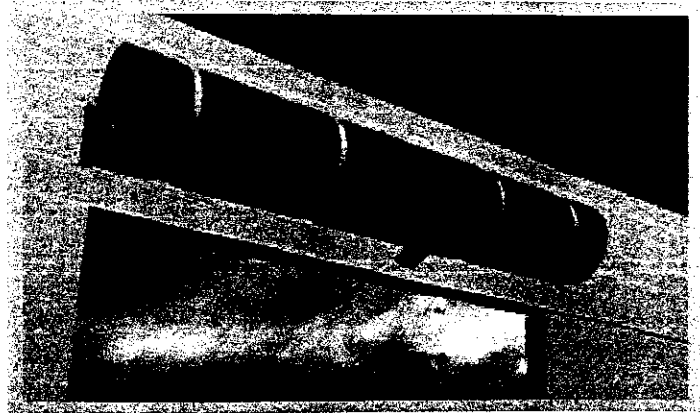

PRE-TENSION DOOR SPRINGS

Figure 7

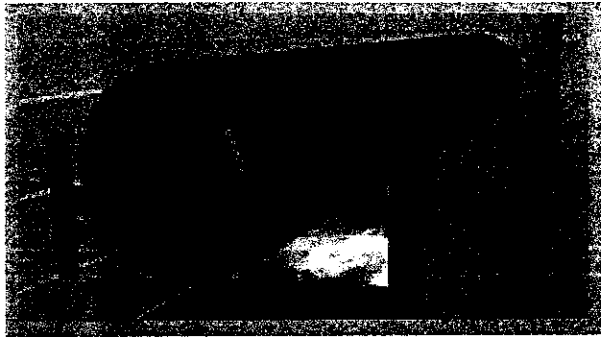

CUTTING THE BANDS

Figure 8

9 CUTTING THE BANDS

9A Cut the shipping bands that hold the curtain in a roll. Then pull the curtain down no farther than halfway.

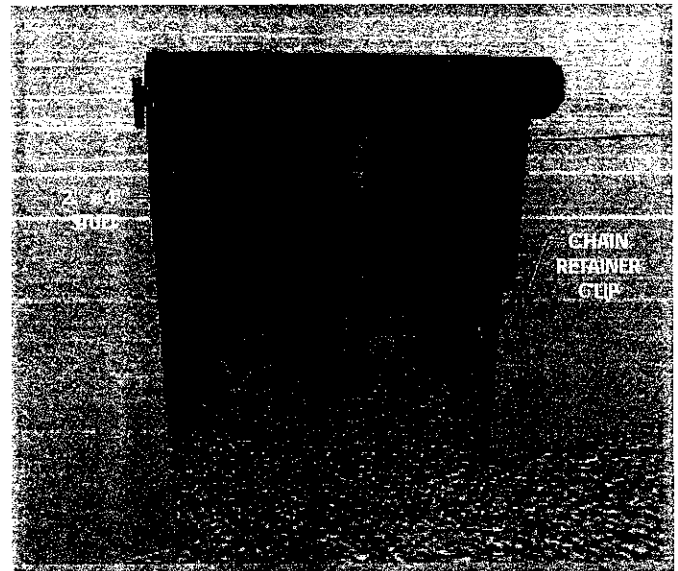

HOLDING THE DOOR OPEN

Figure 9

NOTE: The welding of guides to jambs is NOT recommended.

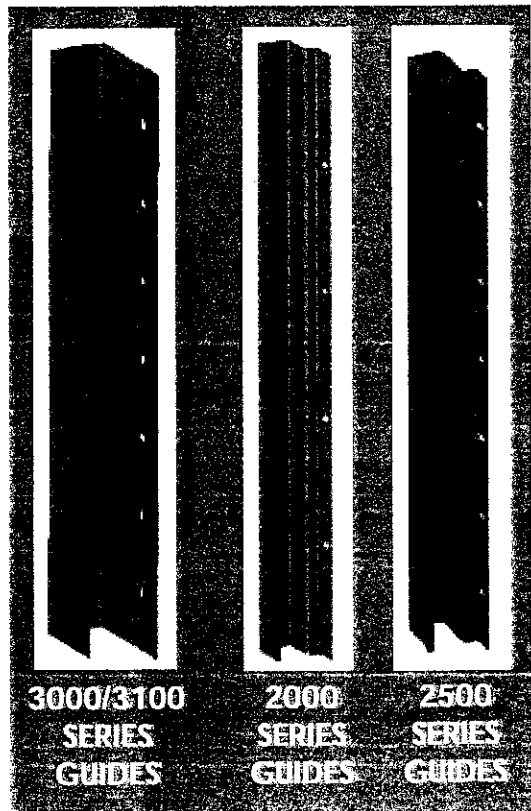

3000/3100
SERIES
GUIDES

2000
SERIES
GUIDES

2500
SERIES
GUIDES

GUIDE RAIL SELECTION

Figure 10

10 INSTALLING GUIDE RAILS, HEAD STOPS AND CHAIN RETAINER CLIP

10A Slide the guides over the edges of the door curtain while positioning them firmly against the door jambs. Allow 1/4" clearance between the edges of the curtain and the insides of both guides. Check the guides for plumb with a level.

10B Fasten the guide rails to the door jambs with the 5/16" fasteners included with the door (as shown in Figures 10, 11A & 11B).

10C Install the removable Head Stop (as shown in Figure 14).

10D Install the chain keeper clip (as shown in Figure 14).

11 STEP Number 8

INSTALLING THE SLIDE BOLT LOCK AND LIFT CLIPS

- 11A Install the slide lock as indicated in Figure 12.
 11B Install the step plates as indicated in Figure 12.

12 STEP Number 9

CHECKING AND ADJUSTING THE DOOR BALANCE

- 12A If door lowers easy and raises hard:
MORE tension is required.
 If door lowers hard and raises easy:
LESS tension is required.

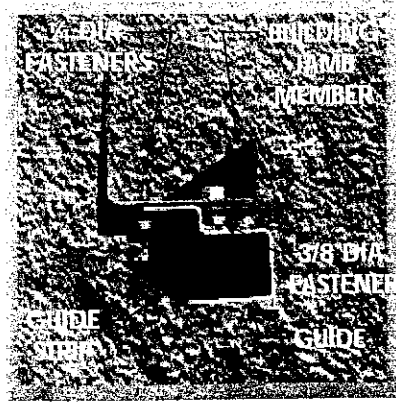

STEEL & WOOD JAMBS
 Figure 11A



MASONRY JAMBS
 Figure 11B

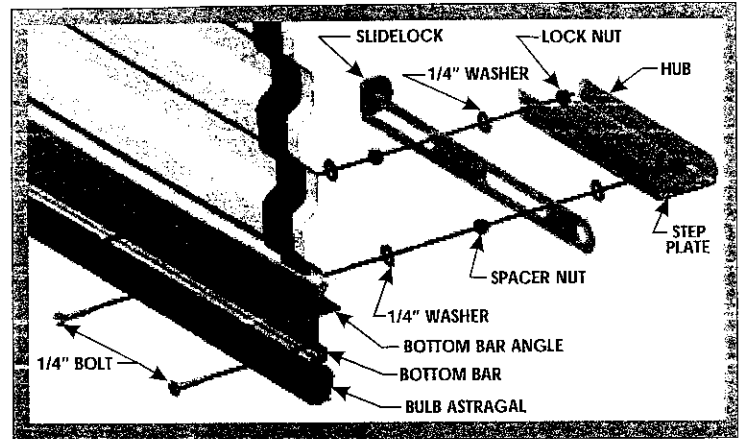

SLIDE BOLT LOCK & LIFT CLIPS
 Figure 12

12B Secure door in "full up" position by one of the following methods to prevent door from falling in the event that the wrench slips.

1. Tie a rope around the door roll, while still engaged in the guides.
2. Place a clamp on the guide rail(s) just below the bottom bar.

12C Place a large pipe wrench in the position (as shown in Figure 13).

Loosen the axle saddles and pull down on the door's bottom bar for more tension, let up on the door's bottom bar for less tension.



12D Tighten the axle saddles down onto the door bracket to 40 Foot pounds per step number 7 (as shown in Figure 5).

12E Test the door as indicated in the previous steps listed above.

12F Repeat any aforementioned step as needed, if further adjustment is required.

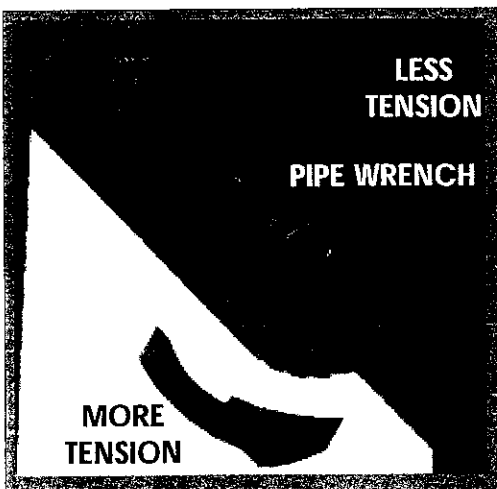

TENSIONING COMMERCIAL DOOR

Figure 13



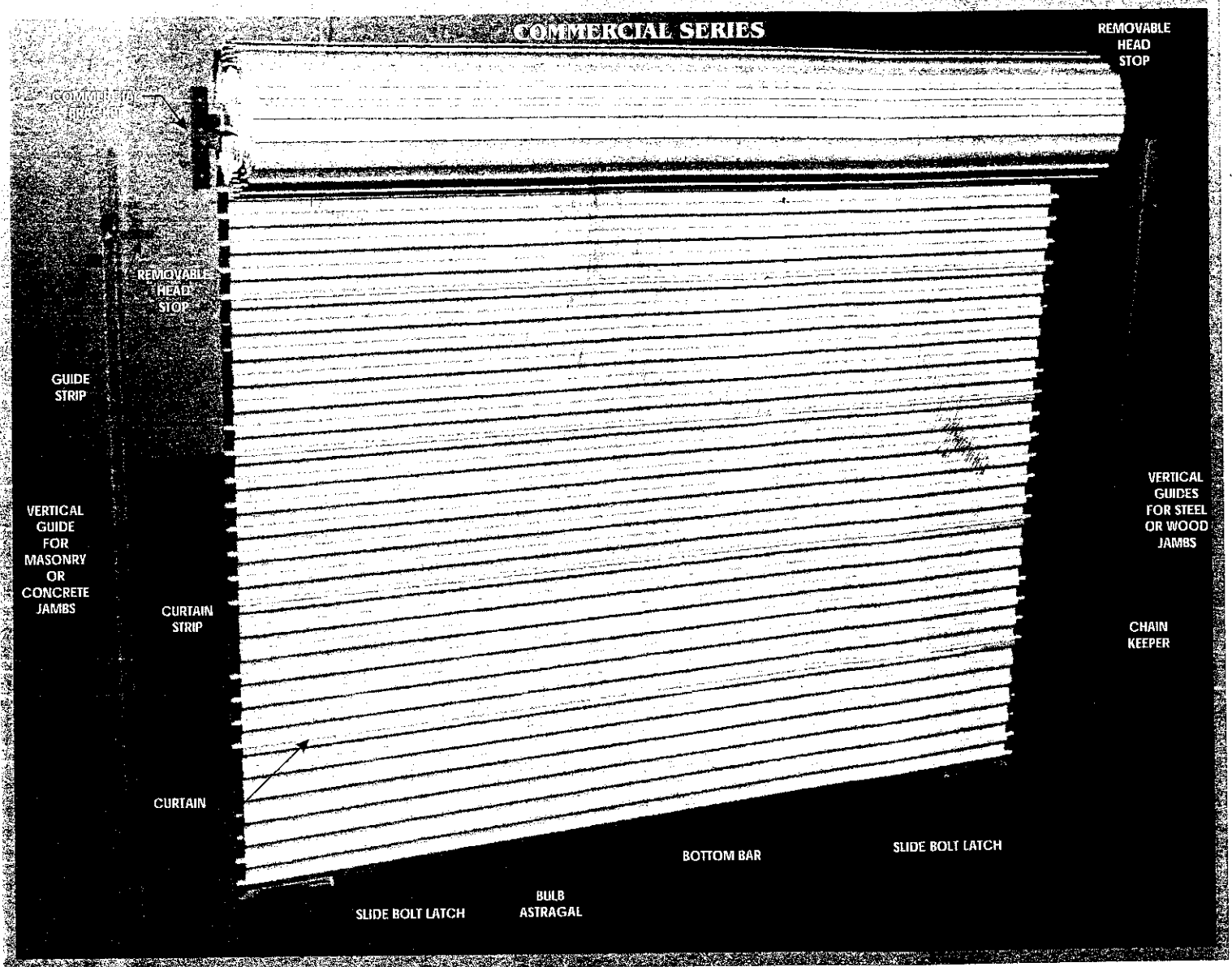

COMMERCIAL PARTS LIST

Figure 14

MAINTENANCE INSTRUCTIONS

IN ORDER TO PROMOTE LONGEVITY OF YOUR DBCI DOOR SYSTEM, IT IS RECOMMENDED THAT THE FOLLOWING MAINTENANCE PROCEDURES BE PERFORMED APPROXIMATELY ONCE A YEAR.

ASTRAGAL

Periodically wipe the dirt off of the length of the Astragal.

SPRINGS

Periodic adjustments to the spring tension may be necessary.

GUIDE STRIPS

Guides are self-lubricating, but must be kept free from dirt to work their best. Wipe dirt from inside of guides to assure smooth operation of doors. A greaseless lubricant, such as silicone spray, may be used.

TO OUR MANY CUSTOMERS

We at DBCI would like to thank you for making us the industry leader in door and building systems: As always, we endeavor to infuse the highest quality of craftsmanship into all of our products and we hope that this is evident to you, our customers. If you would like a tour of our manufacturing facility, please feel free to contact us at 1 (800) 542-0501. We know that you will enjoy many years of trouble-free service. Again, we thank you.

